

---

User Manual for the

# ***WET Sensor***

type **WET-2**

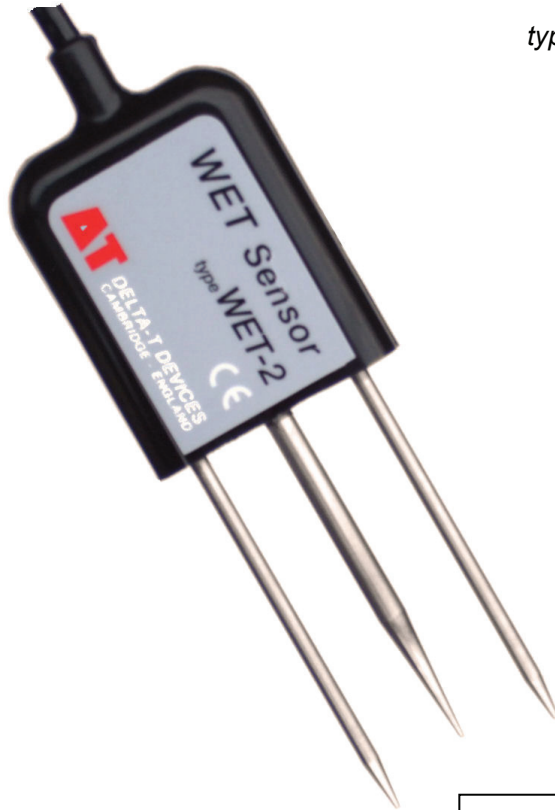

WET-UM-1.4

# **AT**

***Delta-T Devices Ltd***

# Notices

## Copyright

All rights reserved. Under the copyright laws, this manual may not be copied, in whole or in part, without the written consent of Delta-T Devices Ltd. Under the law, copying includes translation into another language.

Copyright © 2007 Delta-T Devices Ltd.

## Acknowledgements

This sensor system has been developed in co-operation with:

Wageningen University and Research Center

The Netherlands,

PPO

Naaldwijk, The Netherlands

and

Saint-Gobain Cultilène B.V.

Tilburg

The Netherlands



GREENHOUSE TECHNOLOGY  
WAGENINGEN UR



FRAKTIJKONDERZOEK  
PLANT & OMGEVING  
WAGENINGEN UR



## Trademarks

All manufacturers' trademarks are acknowledged. Some names referred to are registered trademarks.

## CE conformity

The WET Sensor type WET2 conforms to EC regulations regarding electromagnetic emissions and susceptibility when used according to the instructions contained within this user manual, and is CE marked by Delta-T Devices Ltd

## Design changes

Delta-T Devices Ltd reserves the right to change the design and specification of its products at any time without prior notice.

**User Manual: WET-UM-1.4 February 2007**



Delta-T Devices Ltd  
130 Low Road, Burwell  
Cambridge CB25 0EJ  
UK

Tel: +44 (0)1638 742922  
Fax: +44 (0)1638 743155  
email: [sales@delta-t.co.uk](mailto:sales@delta-t.co.uk)  
web: [www.delta-t.co.uk](http://www.delta-t.co.uk)

# Contents

<b>Introduction to the WET Sensor</b>	<b>4</b>
Description	4
How the WET Sensor works	5
Unpacking	6
<b>Care and Maintenance</b>	<b>7</b>
Sensor care	7
Quick Start	8
<b>Taking Readings</b>	<b>9</b>
Options	11
<b>Calibration</b>	<b>14</b>
Soil Calibrations	14
Pore Water Conductivity	17
<b>Recalibration</b>	<b>20</b>
<b>Connection</b>	<b>20</b>
<b>Specifications</b>	<b>21</b>
Reading range and error sources	22
<b>Technical Reference</b>	<b>24</b>
Dielectric properties	24
Measuring Soil Moisture	25
Calculating Water Deficit	26
Pore water conductivity	26
References	33
Definitions of Terms	34
Interfacing to the WET Sensor	37
<b>Technical Support</b>	<b>38</b>
Acknowledgements:	40
<b>Index</b>	<b>41</b>

# Introduction to the WET Sensor

---

## Description

The WET Sensor is a multi-parameter sensor for use in soils, composts and other artificial growing media. It measures the dielectric properties of the soil and calculates:

- ◆ **W**ater Content
- ◆ **E**lectrical Conductivity
- ◆ **T**emperature

The sensor converts the measured dielectric properties into **Water Content** over the full range, 0 – 80%, using calibration tables. Generalised calibrations are provided for most common soil types, and specialised calibrations are available as separate cost options for a number of artificial substrates.

The WET Sensor also calculates **Pore Water Conductivity**, the Electrical Conductivity of the water within the pores of the soil ( $EC_p$ ). Its calculation is based on a unique formula that minimises the effects of probe contact and soil moisture on the readings.

**Temperature** is measured using a miniature sensor built into the central rod.







The WET Sensor is designed to be used with the HH2 Moisture Meter, but can also be interfaced to control systems for fertigation control.

### ***Advantages of the WET Sensor***

- Rapid measurements (~5 seconds) of all 3 parameters
- In situ Pore Water Conductivity measurements
- Easy insertion into growing media and soil
- Calibrations available for many soils and growing media
- Stable, accurate readings from
  - 0 to 80% water content
  - 0 to ~600 mS.m<sup>-1</sup>
  - 0 to 40°C
- Lightweight ergonomic design

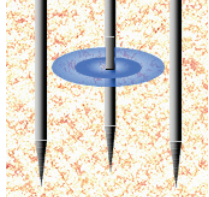

# How the WET Sensor works

## Measurement Principle

	<p>When you insert the WET Sensor into soil and take a reading...</p>
	<p>...it generates a 20MHz signal...</p>
	<p>...which is applied to the central rod, and produces a small electromagnetic field within the soil.</p>
	<p>The water content, electrical conductivity, and composition of the soil surrounding the rods...</p>
	<p>...determines its <b>dielectric properties</b>.</p>
	<p>The WET sensor detects these dielectric properties from their influence on the electromagnetic field...</p>
	<p>...and sends this information to the HH2.</p>
<div style="border: 1px solid black; padding: 5px; background-color: #e0f0e0;"> <p>Soil Moisture 26.5 %</p> </div>	<p>The HH2 calculates <b>Soil Moisture</b> using its calibration tables (Water has a dielectric constant <math>\epsilon'</math> ~ 81, compared to soil ~ 4, and air <math>\approx</math> 1)...</p>
<div style="border: 1px solid black; padding: 5px; background-color: #e0f0e0;"> <p>Pore Water EC 305 mS.m<sup>-1</sup></p> </div>	<p>...calculates the <b>Pore Water Conductivity</b>...</p>
<div style="border: 1px solid black; padding: 5px; background-color: #e0f0e0;"> <p>Temperature 22.1 °C</p> </div>	<p>...and displays the <b>Temperature</b>.</p>

# Unpacking

Your consignment should have the following parts:

Part:		Sales code	Description
WET Sensor		WET-2/d WET-2/p WET-2/w	Sensor either fitted with 1.5m cable and 25-way D connector (/d) or 9-way D connector (/p), or 5m cable and bare wire termination (/w)
CD or floppy disk		-	CD or floppy disk with probe calibration file.
Manual		-	This one!

and may contain some of the following:

Moisture Meter		HH2	Moisture Meter with battery and connector cap,
Plus accessories			see HH2 user manual
Substrate calibrations	(no physical part: factory installed into the HH2)	WET-ST-1 WET-GH-1 WET-CL-1	Optional calibrations for a number of common greenhouse growing media.

Plus

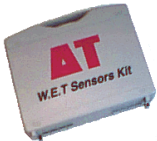
Case		WCC1	Carrying case for WET Sensor, HH2 and spare batteries.
------	---	------	--

# Care and Maintenance

**\*\* CAUTION \*\***

**WET-2 is unsuitable for use in hard soils or substrates, unless holes are pre-formed. Rough handling may cause irreparable damage to the pins.**

---

## Sensor care

The WET Sensor is designed to be robust and trouble-free in normal use, but please observe the following sensible precautions:

- **Look after the sensor rods. Don't attempt to push the probe through stones or extremely hard soil.**  
*(If in doubt, use an insertion tool to make pilot holes before inserting the WET Sensor)*
- **Do not pull the WET Sensor out of the soil by tugging on its cable.**
- **The WET Sensor is fully sealed and may be safely immersed in water, but the interface connectors are not sealed, and should be kept dry.**
- **The WET sensor can be buried to a depth of 2 metres.**
- **Rinse the WET Sensor in tap water and wipe off after use.**

---

*Warning: you need to take reasonable precautions to protect the WET Sensor from physical damage to the rods and from static damage. When not in use it is advisable to keep the sensor with the rods inserted into conductive foam, or use the packing materials provided.*

---

---

# Quick Start

If your WET Sensor has been supplied with an HH2, and you are confident that you know what you're doing, the following instructions should get you started with minimum delay. The section below, **Taking Readings**, gives a more detailed explanation.

Note that the HH2 **must** have the appropriate probe calibration (.CAL file) loaded before any readings can be taken. This file is supplied with your WET sensor on a CD or floppy disk – it may need to be reloaded into your HH2 (see HH2 User Manual) if the HH2 battery has not been continuously maintained.

1. Plug your WET Sensor into the HH2.
2. Turn the HH2 on by pressing the **[Esc]** key.
3. Press **[Set]**, scroll down to **◆ Device**, press **[Set]** again, and check that the device is set to WET.
4. Press **[Set]** again, scroll down and select a suitable soil type.
5. Carefully push the probe into the soil.
6. Press **[Read]** to take a reading
7. Press **[▼]** to scroll down through the measured parameters (water content, pore water conductivity and temperature)
8. Press **[Store]** to store this reading and prepare for the next one



# Taking Readings

Main stages required for taking and storing a reading with an HH2:

<b>Plug in</b>	Plug the WET Sensor into 25-way D-connector socket at the bottom of the HH2.
<b>Power up</b>	If the LCD display is blank, press the <b>Esc</b> key to wake it up. If necessary, press <b>Esc</b> key again until HH2 displays: <pre>Delta-T Devices ΔT Moisture Meter</pre>
<b>Set Device</b>	Press the <b>Set</b> key, and then the <b>▼</b> key until the HH2 displays: <pre>Options: ◆ Device</pre> Press <b>Set</b> again, then the <b>▼</b> key until the HH2 displays: <pre>Device: ◆ WET</pre> Press <b>Set</b> and then <b>Esc</b> .  Note: If <b>WET</b> option is not displayed, WET Sensor calibration file must be loaded into HH2. This requires the HH2Read program, (see instructions in HH2 user manual).
<b>Check</b>	Press <b>Set</b> and then <b>▼</b> until the HH2 displays: <pre>Options: ◆ Status</pre> Press <b>Set</b> again, then <b>▼</b> until the HH2 displays: <pre>Status: ◆ Resources</pre> Press <b>Set</b> , and the HH2 will display current memory and battery condition: <pre>Mem 11% Batt 27% Readings #96</pre> In this example HH2 indicates 11% of its memory has been used and 27% of the battery life is remaining.

Options	<p>These are detailed in the next section. However...</p> <p>...although default HH2 settings will enable you to take a reasonable reading, both the water content and pore water conductivity readings depend on your choice of soil type and calibration values. It's very likely that you will need to Set your <b>Soil Type</b>, and possibly <b>Soil Set-Up</b> as well, before achieving accurate readings.</p>
Insert	<p>Push the WET Sensor into the soil or substrate.</p> <p><i>If ground is hard or stony, use an insertion tool to make guide holes first.</i></p>
Read	<p>Press <b>Read</b> to take a sample. There will be a few seconds delay while readings are taken, results will appear on the screen, like this:</p> <div data-bbox="269 523 519 587" style="border: 1px solid black; padding: 2px; margin: 5px 0;"> <p>WET                      Store? 25.6%vol                  ◆ wet</p> </div> <p>In this example the <b>Water Content</b> has been calculated to be 25.6 %. Arrow keys can be used to scroll down and view other parameters:</p> <p><b>Pore Water Conductivity (EC<sub>p</sub>):</b></p> <div data-bbox="269 724 519 788" style="border: 1px solid black; padding: 2px; margin: 5px 0;"> <p>WET                      Store? 316mS.m<sup>-1</sup>                  ◆ EC<sub>p</sub></p> </div> <p>If probe has been inserted into a medium with a low water content, HH2 will not be able to calculate pore water conductivity accurately, and instead displays:</p> <div data-bbox="269 938 519 1002" style="border: 1px solid black; padding: 2px; margin: 5px 0;"> <p>WET                      Store? Too Dry                      ◆ EC<sub>p</sub></p> </div> <p><b>Temperature:</b></p> <div data-bbox="269 1050 519 1114" style="border: 1px solid black; padding: 2px; margin: 5px 0;"> <p>WET                      Store? 22.9 °C                      ◆ Tmp</p> </div>
Store	<p>Press <b>Store</b> key to save reading, or <b>Esc</b> to discard it.</p>
Off	<p>HH2 automatically goes to sleep after 1 minute, but you can turn it off manually by pressing <b>Esc</b> key until title screen is displayed, and then once more to switch off.</p> <p>Pressing the <b>Esc</b> key will wake it into the same state as when it went to sleep.</p>

## Options

This table lists options available on the HH2 which are particular to the WET Sensor, (for details of the other menu options, refer to the HH2 user manual).

Data:	
Plot ID	This is a single letter data label (A..Z)
Sample	A number that is stored with each reading for identification purposes. It automatically increments with each reading, but can be set manually between 1..2000
Device ID	Label, not usually required with WET Sensors, since each different probe requires loading a new calibration file (number between 0..255)
Root Depth	Enter the rooting depth of your plants (0..9950mm). This is mostly used for calculating water deficits (see below).
Sensor Depth	Describes the depth of the sensor if it is being used to generate a depth profile (0..9950).
Erase	Use for erasing all stored readings.
Soil Type:	
Mineral Organic Sand Clay ----- Custom1 .. Custom5 ----- Coir Min wool v ..	<p>The HH2 requires a soil calibration in order to convert the soil permittivity reading (<math>\epsilon'_b</math>) into water content. The HH2 provides a choice of:</p> <ul style="list-style-type: none"> <li>• 4 generalised calibrations (Mineral, Organic, Sand, Clay)</li> <li>• 5 spaces for user calibrations (Custom1..5)</li> <li>• 5 specialised calibrations for greenhouse growing media (only available if WET-CL has been purchased)</li> </ul> <p>These calibrations are explained in the Calibration section.</p>

### Soil Set-Up:

Parameter	<p>This soil parameter appears in the equation from which the Pore Water Conductivity, <math>EC_p</math>, is calculated. The default value is 4.1, but values between 1.0..9.0 can be used.</p> <p>The <b>Calibration</b> section explains how to measure a value for the soil parameter, and the <b>Technical Reference</b> section describes how the parameter is used in the <math>EC_p</math> calculation.</p>
Capacity	<p>The field capacity of the soil can be set between 0..100%vol soil water content.</p> <p>The <b>Technical Reference</b> section describes how this is used in the calculation of the soil deficit, mmDef. The HH2 User Manual contains information and advice on obtaining values of field capacity for different soils.</p>
b0	<p>This option is only available for Custom1.. Custom5 soil types.</p> <p>The soil water content is calculated from the soil dielectric (<math>\epsilon_b</math>) reading, using an offset value <math>b_0</math> and a scaling factor <math>b_1</math>.</p> <p><math>b_0</math> can be set to a value between -25..+25, but should normally be between 1.0 and 2.3</p>
b1	<p><math>b_1</math> can be set between 0..49.9, but should normally be between 6.0 and 12.0.</p>

### Units:

Conductivity	You can choose to display and store the conductivity readings in either $mS.m^{-1}$ , $mS.cm^{-1}$ or $\mu S.cm^{-1}$
Water Content	Choose either %vol or $m^3.m^{-3}$ .

### Display:

<p>W E T</p> <p>or</p> <p>W E T <math>EC_b</math> <math>\epsilon_b</math></p> <p>or</p> <p>W E T mmDef</p>	<p>By default, the HH2 calculates, displays and stores the Water Content, Pore Water Conductivity (<math>EC_p</math>) and the Temperature.</p> <p>It can be set to display the permittivity (<math>\epsilon_b</math>) and bulk soil conductivity (<math>EC_b</math>) as well, for reference.</p> <p>Alternatively, the HH2 can be set to calculate and display the soil deficit, i.e. the amount of water required to refill a soil to its field capacity (see also Root Depth and Capacity).</p>
--	---

Compensation:	
Temperature	<p>Conductivity readings (both Pore Water and Bulk) are affected by temperature, and it is common practise to apply a correction so that they are quoted at a standard temperature.</p> <p>You can choose to apply temperature compensation to 20 °C or 25 °C, or to take uncompensated readings (None).</p>
Percent	<p>Used to set the % rate at which temperature compensation will be applied. The default value is 2.0, but you may choose between -1.0..4.0%. See <b>Calibration</b> section for suggested values for different ions.</p>

## Output File

Details of the output file from the HH2 are given in HH2 user manual, but for WET Sensor readings the file will look similar to this:

Device >>	WET							
Root Depth >>	0							
Sensor Depth >>	0							
Soil >>	Mineral							
B0 >>	1.6							
B1 >>	8.4							
Soil Parameter	4.1							
Field Capacity	0.38							
EC Compensation	None							
Time	Sample	Plot	Device	VWC	ECp	Tmp	E'b	ECb
				% Vol	mS.m-1	degC		mS.m-1
01/01/00 23:51	23:51	1 A	0	27.5	166.1	27.6	15.3	24
01/01/00 23:51	23:51	2 A	0	32	176.9	28.3	18.4	32.8
01/01/00 23:53	23:53	3 A	0	41.6	187.8	29.9	25.9	53.7
01/01/00 23:53	23:53	4 A	0	21.4	246.7	29.7	11.5	24

# Calibration

This section mainly describes the different **soil calibrations** that are used to convert the WET Sensor's dielectric readings into soil moisture measurements.

The WET sensor also needs soil parameter and temperature compensation values in order to derive its measurements of **pore water conductivity**. And the **soil moisture deficit** calculation requires root depth and field capacity values.

## Soil Calibrations

The WET Sensor calculates soil moisture values using a simple mixing formula that relates water content ( $\theta$ ) to the measured permittivity of the soil ( $\epsilon'_b$ ) using the equation:

$$\theta = (\sqrt{\epsilon'_b} - b_0) / b_1 \tag{1.1}$$

Since the WET Sensor measures  $\epsilon'_b$  directly, the calibrations consist of pairs of coefficients,  $b_0$  and  $b_1$ .

### Generalised Soil Calibrations

Calibration	$b_0$	$b_1$
Mineral	1.8	10.1
Organic	1.4	8.4
Sand	1.4	8.4
Clay	2.0	11.0

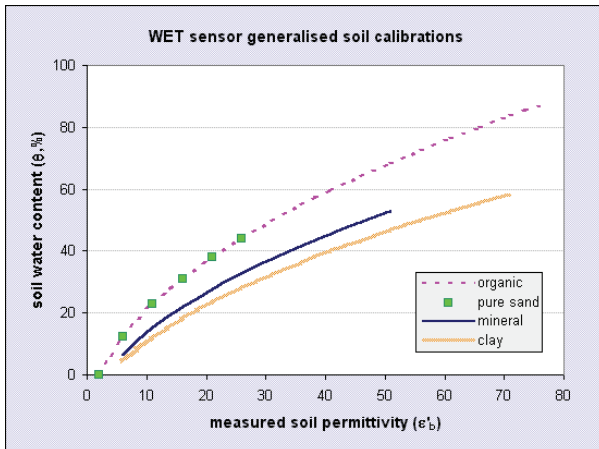

---

*Warning: It is very important to use the correct soil calibration.*

*You can see from the graph above that a WET sensor reading of  $\varepsilon'_b = 40$  would be interpreted as ~40% water content using the generalised clay calibration, but ~60% using the organic or sand calibrations. If in doubt, you must generate a soil-specific calibration (see below).*

---

## **WET-CL Substrate Calibrations**

These calibrations have been developed by PPO in the Netherlands (see **Acknowledgements**), and are specific to a range of common greenhouse growing substrates:

<i>Calibration</i>	<i>Description</i>	<i>Density kg.m<sup>-3</sup></i>	<i>Porosity %</i>
<b>WET-ST-1</b>			
Min wool v	mineral wool or glasswool WET sensor vertical	45 - 60	96
Min wool h	mineral wool, WET sensor horizontal	60	96
<b>WET-GH-1</b>			
Coir	compost based on coir (processed coconut fibre)	85	98
Peat based	peat based composts, may include clay or perlite	75 - 250	55 – 80
Min g/h soil	average of a wide range of greenhouse soils	1100	55
Pot soils	potting composts including roots	-	-

## **Soil-specific Calibrations**

If the generalised or WET-CL calibrations are not appropriate for your soil, you will need to do a soil-specific calibration. The aim of this is to generate the coefficients  $b_0$ ,  $b_1$  which can be entered into the HH2's custom calibrations.

Ideally you should do this by taking an undisturbed core of a known volume of damp soil and measure its permittivity ( $\varepsilon'_b$ ) and weight at intervals while carefully air-drying it. Use the measured damp weights, dry weight and volume to calculate the water contents corresponding to the measured permittivities. Finally graph refractive index,  $\sqrt{\varepsilon'_b}$ , against water content,  $\theta$ , fit a trendline to the data points and then  $b_0$  and  $b_1$  will be the offset and slope of that line (see e.g. graph in **Theory** section).

However, for most purposes a simple 2-point calibration is sufficient, and we suggest you use the following protocol:

You will need:

- a WET Sensor
- an HH2 with its **Display**: option set to “WET EC<sub>b</sub> ε<sub>b</sub>”
- a non-metallic oven-proof container for a sample of ~1 litre of soil
- access to a temperature controlled oven or equivalent, for drying the soil sample

**Step 1** Collect a sample of damp soil, disturbing it as little as possible so that it is at the same density as in situ. Insert the WET Sensor into the sample and measure the permittivity,  $\varepsilon'_w$ .

Weigh the damp sample, ( $W_w$ ), and measure its volume ( $L$ ).

**Step 2** Oven-dry the sample and weigh it ( $W_0$ ). Insert the WET Sensor into the dry soil ( $\theta \approx 0$ ), and measure the permittivity,  $\varepsilon'_0$ .

Then  $b_0 = \sqrt{\varepsilon'_0}$

It will usually have a value between 1.0 and 2.5

**Step 3** Calculate the volumetric water content ( $\theta_w$ ) of the original sample:  $\theta_w = \frac{(W_w - W_0)}{L}$

**Step 4** Then  $b_1 = \frac{\sqrt{\varepsilon'_w} - \sqrt{\varepsilon'_0}}{\theta_w}$

It will usually have a value between 7.5 and 11.5.

### **Example:**

1. In a sample of moist soil, the WET Sensor gives a reading of  $\varepsilon'_w = 9.06$ . I.e.  $\sqrt{\varepsilon'_w} = 3.01$   
This sample weighs 1.18kg, and has a volume of 0.75 litres.
2. After drying the sample of soil, the WET Sensor gives an output of  $\varepsilon'_0 = 2.56$ .

From this we can calculate  $\sqrt{\varepsilon'_0} = b_0 = 1.59$ .



3. The dry sample now weighs 1.05 kg, so the volume of water in the moist sample was  $1.18 - 1.05 = 0.13$  litres.

Volumetric water content of the sample  $\theta_w = 0.13/0.75 = 0.173 \text{ m}^3.\text{m}^{-3}$ .

4. By substituting in equation [1.],  $b_1 = 8.19$

## Pore Water Conductivity

The WET sensor calculates pore water conductivity using the relationship:

$$EC_p = \frac{\varepsilon'_p \times EC_b}{(\varepsilon'_b - \varepsilon'_{\sigma_b=0})}$$

The symbols and derivation of the formula are explained in the **Reference** section.

The WET sensor directly measures  $\varepsilon'_b$  and  $EC_b$ , and calculates  $\varepsilon'_p$  from the temperature. The remaining parameter,  $\varepsilon'_{\sigma_b=0}$ , is called the Soil Parameter, and varies slightly for different soils.

### Soil parameter

The default value is suitable for a range of both organic and mineral agricultural soils. However if you are taking measurements in heavy clay or sand, or some other unusual medium, you may want to calculate a value that is specific to that medium.

---

**Warning:** *the soil parameter should be left at the default value of 4.1 unless you have measured it for your soil. Changing it will significantly affect the  $EC_p$  readings, especially in dry soils.*

---

We suggest you use the following procedure:

1. Take a sample of soil (~300ml) and put this in a wide-mouth bottle that has a sealable cap. The quantity of soil is not critical, but needs to be enough so that you insert the WET sensor fully and avoid edge effects, i.e. ~70mm diameter x 75mm high.
2. Add tap water of approximately twice the soil volume (600ml). The conductivity of the tap water is not critical, but the volume needs to be sufficient to saturate the soil and leave enough fluid above the soil to immerse the WET Sensor.
3. Mix **very thoroughly**, preferably by shaking the closed container for ~10 minutes.
4. Let the soil settle for an hour.

5. Measure the permittivity ( $\epsilon'_w$ ) and conductivity ( $EC_w$ ) of the free water on top of the soil using the WET Sensor with the HH2 set to display  $W E T \epsilon_b EC_b$ .
6. Push the WET Sensor down into the soil and measure the bulk conductivity ( $EC_b$ ) and permittivity ( $\epsilon'_b$ ) in the saturated soil below.
7. The soil parameter  $\epsilon'_{\sigma_b=0}$  can then be calculated from the formula:

$$\epsilon'_{\sigma_b=0} = \epsilon'_b - \frac{(\epsilon'_w \times EC_b)}{EC_w}$$

## Temperature compensation

The WET Sensor readings can be temperature compensated if required.

For some applications it is useful to know the true electrical conductivity at the measurement temperature. In that case uncompensated readings are required, and this is the default for the WET Sensor.

However, for most applications the electrical conductivity is a means of estimating the ionic content of the pore water, and for those applications it is necessary to compare readings after they have been adjusted to a standard temperature. Unfortunately this isn't straightforward because:

- 20°C and 25°C are both used as standards,
- The temperature compensation percentage depends on the particular mixture of ions present in the pore water. For example:

<i>ion</i>	<i>temperature sensitivity of EC*</i>
<b>Na<sup>+</sup></b>	2.1
<b>K<sup>+</sup></b>	1.9
<b>½ Ca<sup>++</sup></b>	2.1
<b>H<sup>+</sup></b>	1.5
<b>NH<sub>4</sub><sup>+</sup></b>	1.9
<b>Cl<sup>-</sup></b>	1.9
<b>NO<sub>3</sub><sup>-</sup></b>	1.8
<b>OH<sup>-</sup></b>	1.5
<b>P<sub>2</sub>O<sub>5</sub><sup>-</sup></b>	not known

\* The values quoted are approximate for 25°C.

The choice of standard temperature and compensation % will depend on what is commonly used for comparison purposes within your application.

## Sensor Calibration

We usually refer to the WET Sensor measuring dielectric properties, but this is not strictly true.

The sensor itself really measures the capacitance ( $C$ ) and resistance (or its reciprocal, conductance,  $G$ ) of the material between the rods. It infers the dielectric properties using a sensor calibration file, <WETxyyy.cal> where yyy is the sensor serial number (xx is batch number), which contains sets of capacitance and conductance readings obtained when the sensor was calibrated in reference fluids with known dielectric properties.

Each WET Sensor requires its own individual calibration file.

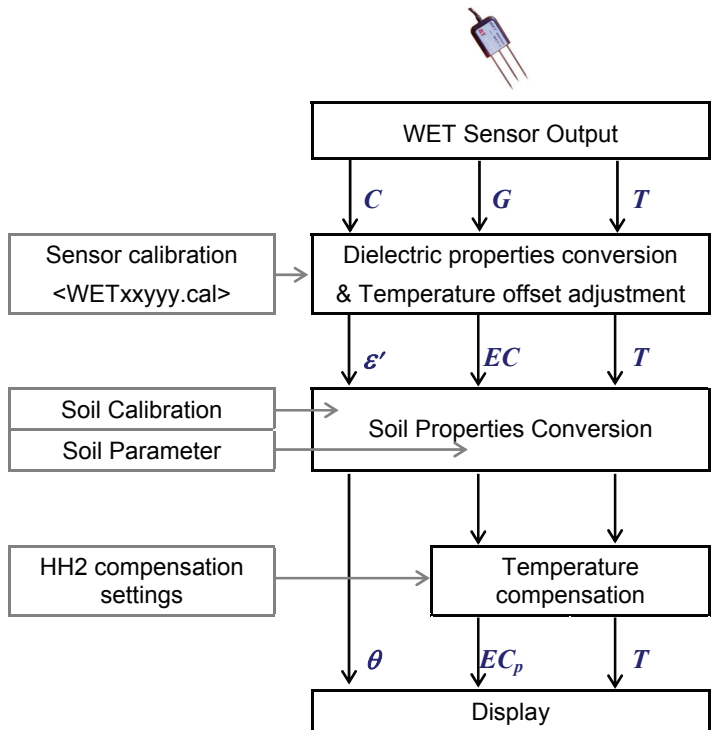

---

# Recalibration

Periodically you should test the accuracy of the WET Sensor by checking the conductivity and permittivity readings in a low conductivity aqueous solution.

The Pore Water Conductivity reading should be checked against a reading obtained with an accurate conductivity meter. Remember to set the temperature compensation to be the same in the conductivity meter and the HH2.

You can check the permittivity reading ( $\epsilon'_b$ ) in tap water at temperature  $T$  °C by comparing the value displayed by the HH2 against the following approximate formula:

$$\epsilon'_b(T) = 87.48 - 0.365T$$

If the WET Sensor readings are outside specification, it should be returned to the supplier for recalibration.

---

# Connection

Table below details WET sensor cable connections for current and previous cable versions:

Colour	Previous	Function	Comment
Red	Red	Power Vin	+5 to +9VDC
Blue	Black	0V	Power 0V
Green	Green	0V	0V
Yellow	Yellow	DATAout	5V Serial data output*
Violet	Turquoise	SDA	EEPROM - data
White	White	SCL	EEPROM - clock
Grey	Pink	WP	EEPROM - write protect
N/A	N/A	BRAID	EMC screen

\* Not RS232

# Specifications

Probe Output		Range	Accuracy	Units	Notes
Serial data for:	Permittivity, $\epsilon'$	1 to 80	$\pm 2.5$	(none)	0 to 40°C, 0.1 to 0.55 m <sup>3</sup> .m <sup>-3</sup> soil moisture content after equilibration (~20s)
	Bulk electrical conductivity, $EC_b$	0 to 300	$\pm 10$	mS.m <sup>-1</sup>	
	<b>T</b> emperature, °C	-5 to 50	$\pm 1.5$	°C	
Which is used to calculate:	<b>W</b> ater Content, $\theta$	0.2 to 0.8 0 to 0.55 0 to 0.55	$\pm 0.04$ $\pm 0.05$ $\pm 0.03$	[1] m <sup>3</sup> .m <sup>-3</sup>	with WET-CL calibrations with supplied soil calibrations after soil-specific calibration
	<b>E</b> lectrical conductivity of pore water, $EC_p$	see graph in following section			
	<b>F</b> requency	20 MHz			
<b>C</b> alibration	Individual sensor calibrations supplied (3.5" FDD)				
<b>E</b> nvironment	Probe sealed to IP67, 25-way D-connector sealed to IP65, 9-way D-connector sealed to IP44 Operating temperature 0 to 40°C				
<b>P</b> ower	Typically 40mA during 2.5s measurement cycle, WET-2 (all versions) 5 to 9 VDC				
<b>D</b> imensions	<b>Probes:</b> 68 long x 3mm diameter, (Centre rod 60mm) <b>Housing:</b> 55 x 45 x 12mm.				
<b>S</b> ampling vol.	~500 ml				
<b>W</b> eight	75g.				

[1] Water Content accuracy specifications apply at 20°C.

---

# Reading range and error sources

## **Water Content accuracy**

The accuracy of your water content readings will depend on:

<i>Error source</i>	<b>Associated with</b>	<b>Notes</b>
<i>Calibration</i>	<b>Soil calibration doesn't match actual soil type</b>	Errors in mineral and sandy soil are usually < 3 or 4%, but can be 5 to 10% in clay and organic soils without a soil-specific calibration.
<i>Soil type</i>	<b>Very fine clay soils</b>	Can display unusual dielectric properties, which reduce accuracy. Require soil-specific calibrations.
	<b>Magnetic soils</b>	Some problems e.g. in Ferralsols
<i>Salinity</i>	<b>High readings</b>	See chart below
<i>Probe insertion</i>	<b>Poor contact between WET Sensor and soil</b>	You can get an idea of the size of this error by wagging the WET Sensor gently in the soil....

## Pore Water Conductivity accuracy

The accuracy of your pore conductivity readings will depend on:

Source of error	Associated with	Notes
Soil type	<b>Very fine clay soils</b>	Can display unusual dielectric properties, which reduce accuracy
	<b>Magnetic soils</b>	Some problems in e.g. Ferralsols
	<b>Artificial media</b>	Require custom soil parameter if reading at low water contents (< 30%)
Salinity	<b>Very saline soils</b>	See chart below
Water content	<b>Dry soils</b>	See chart below
Temperature	<b>Ionic conductivity varies with temperature</b>	See Temperature Compensation above
Probe insertion	<b>Poor contact between WET Sensor and soil</b>	The Pore Water Conductivity reading is less sensitive to probe contact than the Water Content reading – but good contact will always improve accuracy.

## Reading range

The following graph gives an indication of the range of pore water conductivity ( $EC_p$ ) that can be accurately measured by the WET Sensor at different soil moisture levels:

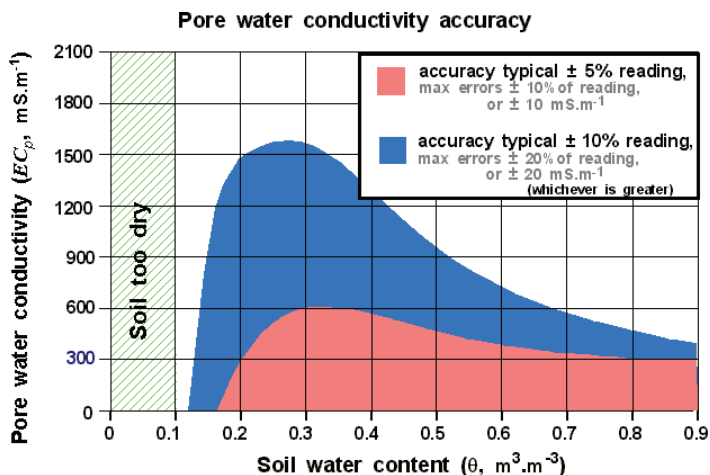

# Technical Reference

---

## Dielectric properties

When an electric field passes through a material (such as soil) some of the energy in the field is transmitted (unchanged), some is reflected, some is stored and finally some is absorbed and converted into heat.

The extent to which each of these occurs within a particular material is determined by its *dielectric properties*. These are quantified by a parameter called the relative electrical *permittivity* ( $\epsilon$ ) of a material which characterises its response to the polarising effect of an applied electric field.

It is usually represented as a complex number,

$$\epsilon = \epsilon' - j\epsilon'' \quad [2.]$$

where the real part of the permittivity,  $\epsilon'$ , represents the energy stored, and the imaginary component,  $\epsilon''$ , represents the total energy absorption or loss. Both values are frequency and temperature dependent.

For a static electric field the real part of the permittivity,  $\epsilon'$ , is often referred to as the dielectric constant.

The energy losses include dielectric loss,  $\epsilon''_d$ , and loss by ionic conduction:

$$\epsilon'' = \epsilon''_d + \frac{EC_i}{\omega\epsilon_0} \quad [3.]$$

where  $EC_i$  is the specific ionic conductivity of the material and  $\omega$  is the radian frequency in  $\text{rad s}^{-1}$ . The frequency in Hz of the applied electric field is  $f = \omega/2\pi$ .

The permittivity for free space is  $\epsilon_0 = 8.854 \cdot 10^{-12} \text{ F m}^{-1}$ .

---

*Note: in the remainder of this theory we've used the symbol  $\sigma$  instead of  $EC$  for the electrical conductivity, in order to simplify the appearance of the equations.*

---



---

# Measuring Soil Moisture

Whalley (ref [1]), White, Knight, and Zeggelin (ref[2]) and Topp (ref [3]) have shown that there is a simple linear relationship between the complex refractive index (which is equivalent to  $\sqrt{\varepsilon}$ ), and volumetric water content,  $\theta$ , of the form:

$$\sqrt{\varepsilon} = a_0 + a_1 \cdot \theta \quad [4.]$$

This equation appears to work very well for most non-magnetic soils and artificial growing media over a range of frequencies between ~1MHz and ~10GHz.

The following graph shows composite data for a number of different agricultural soils taken with the WET Sensor (at 20MHz):

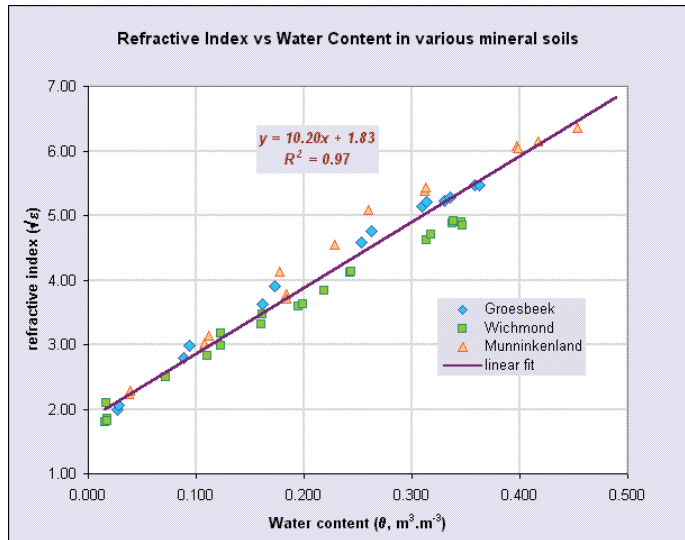

You can see from this graph that the accuracy of the water content measurements would be improved by using a different calibration for each soil. However, the improvement would be small (typically 2 or 3%), so a generalised “mineral” calibration is appropriate for a good range of agricultural soils.

---

*Warning: This is not the case with clay soils, and a soil-specific calibration may improve the accuracy by >10%. This is also true of “organic” soils because that label covers a huge range of soil types.*

---

---

# Calculating Water Deficit

Water Deficit is the amount of irrigation water or rainfall (mm) that has to be added to a soil profile in order to bring it back up to field capacity.

The size of the water deficit will depend on the depth of the soil profile that it relates to (usually taken as some function of the crop rooting depth).

For WET Sensors, the water deficit  $D$  in mm is defined as

$$D = l \cdot (\theta_{FWC} - \theta)$$

- where
- $l$  = Rooting Depth in mm.
  - $\theta_{FWC}$  = Field Water Capacity of the soil spanned by the rooting depth.
  - $\theta$  = Water content of the soil as measured.

---

## Pore water conductivity

The electrical conductivity of the bulk soil,  $\sigma_b$ , is a function of both soil water content,  $\theta$ , and the pore water conductivity  $\sigma_p$ .

This is very similar to the relationship that has been found between the electrical permittivity of the bulk soil,  $\epsilon_b$ , the permittivity of the pore water,  $\epsilon_p$ , and  $\theta$  (e.g. Nyfors and Vainikainen, 1989).

Malicki *et al.* (1994) found a high degree of linear correlation between values of  $\sigma_b$  and  $\epsilon_b$  for a broad range of soil types.

The following discussion proposes a theoretical basis for the relationship between  $\sigma_b$  and  $\epsilon_b$ , and explains how this is used within the WET Sensor to derive readings of pore water conductivity.

### ***Bulk Soil Conductivity v. Pore Water Conductivity***

Consider the water that can be extracted from the pores of the soil matrix. The permittivity and conductivity of the pore water will be denoted by the subscript  $p$ . The imaginary part of the complex permittivity of the pore water is  $\epsilon''_p$ . In soil science it is

more practical to use the conductivity of the pore water,  $\sigma_p$ , which can be defined as:

$$\sigma_p = \omega \varepsilon_0 \varepsilon_p'' = \omega \varepsilon_0 \left( \varepsilon_{dp}'' + \frac{\sigma_{ip}}{\omega \varepsilon_0} \right) \quad [5.]$$

where  $\sigma_{ip}$  represents the ionic conductivity of the extracted pore water. Dielectric losses are frequency dependent and have a maximum at the relaxation frequency. The relaxation frequency of water is 17 GHz at 20°C (Kaatzte and Uhlendorf, 1978). The operating frequency of the WET Sensor is 20 MHz, and at that frequency  $\varepsilon_{dp}''$  is negligible, so Eq. [5] can be reduced to:

$$\sigma_p = \sigma_{ip} \quad [6.]$$

Usually  $\sigma_p$  is referred to as the *EC* (Electrical Conductivity) of the pore water.

Ionic conduction is a function of temperature. In the case of a NaCl-water mixture, the conductivity increases by ~2.1 % per °C. The values quoted for  $\sigma_p$  are often corrected for temperature dependence to a temperature of 20°C (or sometimes to 25°C). This temperature correction depends on the ionic composition of the solution, and is not applied automatically by the WET Sensor.

The complex permittivity of the pore water,  $\varepsilon_p$ , is equal to that of pure water. The real part of the complex permittivity of the pore water  $\varepsilon_p' = 80.3$  at 20°C, with a temperature coefficient of about -0.37 per °C (Kaatzte and Uhlendorf, 1981).

By analogy with Eq. [3] we can write the following approximation for  $\varepsilon_p$ :

$$\varepsilon_p \approx \varepsilon_p' - j \frac{\sigma_p}{\omega \varepsilon_0} \quad [7.]$$

The permittivity and conductivity of the bulk soil will be denoted by the subscript *b*. The complex permittivity of the bulk soil,  $\varepsilon_b$ , is proportional to both  $\varepsilon_p$  and a function of  $\theta$ ,  $g(\theta)$ . For dry soil there is no water to facilitate ionic conduction, so the conductivity of the bulk soil  $\sigma_b \approx 0$ .

However dry soil material is still polarisable, so  $\varepsilon_{\sigma_b=0} \neq 0$  and

$\varepsilon_{\sigma_b=0}$  appears as an offset to  $\varepsilon_b$ .

By assuming that  $g(\theta)$  takes into account the proportionality constant, it is reasonable to postulate the following form for the complex permittivity of the bulk soil:

$$\varepsilon_b = \varepsilon_{\sigma_b=0} + \varepsilon_p g(\theta) \quad [8.]$$

Note that  $\varepsilon_{\sigma_b=0}$  is a complex value and includes dielectric and ionic loss. However since  $\sigma_b = 0$ , we may approximate  $\varepsilon_{\sigma_b=0}$  by its real part  $\varepsilon'_{\sigma_b=0}$ . With this and Eq. [7] substituted in Eq. [8],  $\varepsilon_b$  can be written as:

$$\varepsilon_b = \varepsilon'_{\sigma_b=0} + \varepsilon'_p g(\theta) - j \frac{\sigma_p}{\omega \varepsilon_0} g(\theta) \quad [9.]$$

An electrical model for a dielectric material such as soil between two electrodes is a lossy capacitor. We can calculate the admittance,  $Y$ , of this soil-filled capacitor. The admittance is the inverse of impedance,  $Z$ , and is a complex quantity which is proportional to the permittivity  $\varepsilon_b$  of the bulk soil, and can be defined by:

$$Y = j\omega\varepsilon_0\varepsilon_b\kappa \quad [10.]$$

where  $\kappa$  is a geometry factor which is determined by the distance between the electrodes and their areas in contact with the soil. Note that contact problems of the electrodes with the soil will be reflected in  $\kappa$ .

The equivalent circuit for such a lossy capacitor is a loss-free capacitor,  $C$ , with a conductor,  $G$ , in parallel.  $C$  represents the energy storage capability of the soil and is related to  $\varepsilon'_b$ .

$G$  represents the energy loss and is related to  $\sigma_b$ .  $Y$  may be written in terms of  $C$  and  $G$  as:

$$Y = G + j\omega C \quad [11.]$$

From Eq. [10] and Eq. [11] and with Eq. [3] to Eq. [9] in mind, the real and imaginary parts of  $Y$  can be found:

$$G = \sigma_p g(\theta)\kappa \quad [12.]$$

and

$$C = \varepsilon_0 (\varepsilon'_{\sigma_b=0} + \varepsilon'_p g(\theta))\kappa \quad [13.]$$

In terms of the measurable bulk quantities  $\sigma_b$  and  $\varepsilon'_b$ :

$$\sigma_b = \sigma_p g(\theta) \quad [14.]$$

and

$$\varepsilon'_b = \varepsilon'_{\sigma_b=0} + \varepsilon'_p g(\theta) \quad [15.]$$

From Eq. [14] and [15] the ionic conductivity of the pore water can be written as:

$$\sigma_p = \frac{\varepsilon'_p \sigma_b}{(\varepsilon'_b - \varepsilon'_{\sigma_b=0})} \quad [16.]$$

The model of Eq. [16] describes the relationship between  $\sigma_p$  of the pore water (the water that can be extracted from the soil) and the values  $\varepsilon'_b$  and  $\sigma_b$  as measured in the bulk soil using a dielectric sensor. The offset  $\varepsilon'_{\sigma_b=0}$  can be calculated from the  $\varepsilon'_b$  and  $\sigma_b$  values measured at two arbitrary free water content values.

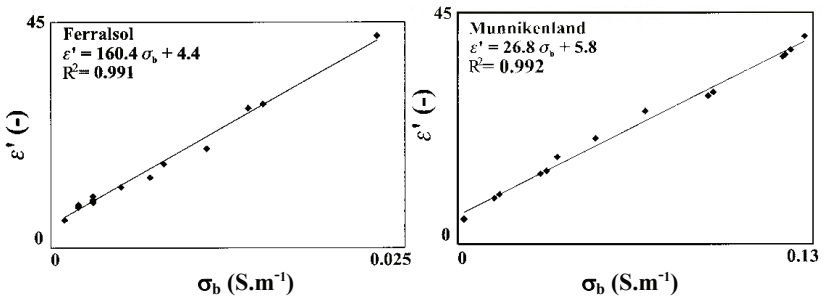

Fig. 1 Examples of the relationship between  $\varepsilon'_b$  and  $\sigma_b$ , showing the offset  $\varepsilon'_{\sigma_b=0}$  for two different soils.

The relationship between the bulk soil parameters  $\varepsilon'_b$  and  $\sigma_b$  and the corresponding pore water parameters  $\varepsilon'_p$  and  $\sigma_p$  is different when the water present is bound to the soil matrix rather than free water. The model of Eq. [16] cannot be used for the conductivity due to ions moving through the lattice of ionic crystals in a dry or almost dry soil - the model is only valid for the free water in the matrix.

Thus  $\varepsilon'_{\sigma_b=0}$  is not the value for  $\varepsilon'_b$  if  $\theta = 0$ . For sand the free water content corresponds to  $\theta > 0.01$  but for clay it can be

$\theta > 0.12$  (Dirksen and Dasberg, 1993). As a rule of thumb the model applies for most normal soils and other substrates used for growing, such as Rockwool, if  $\theta > 0.10$ .

## The design of the Wet Sensor

In Eqs [14] and [15], only the term  $g(\theta)$  is affected significantly by the shape of the electrodes, by the contact between the electrodes and soil, and by the soil composition. This term is eliminated in Eq [16] due to its ratiometric form, and so measurements of pore water conductivity based on this equation are relatively insensitive to contact problems. The WET Sensor exploits this technique by making simultaneous readings of  $\epsilon'_b$  and  $\sigma_b$  within a relatively small sampling volume and at the same frequency.

The probe is built around an ASIC developed specifically for dielectric sensors at IMAG-DLO. This operates as a vector voltmeter to make precision measurements of  $\epsilon'_b$  and  $\sigma_b$ , as shown in the following diagram:

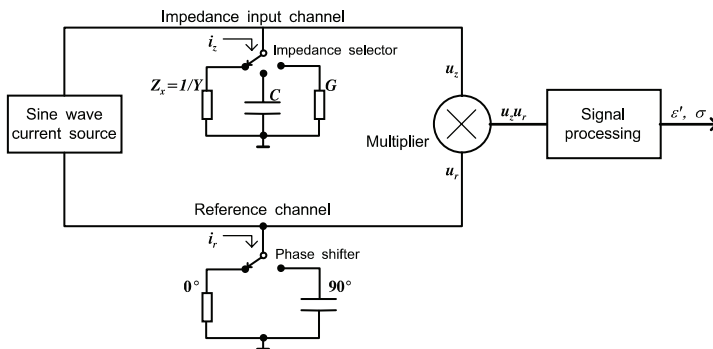

**Fig 2.** Schematic representation of the ASIC circuitry for measuring dielectric properties

## Validation of the Theory

The model of Eq. [16] was evaluated for five different soils, glass beads of 0.2mm diameter and a slab of Rockwool. The soils were samples from the Dirksen and Dasberg (1993) experiment. Their compositions are listed in Table 1. The salinity of the soil samples was not changed.

The salinity of the Rockwool slab and the glass beads were adjusted to  $\sigma_p = 0.3 \text{ S.m}^{-1}$  and  $\sigma_p = 0.1 \text{ S.m}^{-1}$  respectively, using water-NaCl solutions. Sufficient water was left on top of the

saturated samples to measure  $\sigma_p$  of the soil solution. The WET Sensor was used for the measurement of  $\varepsilon'_b$  and  $\sigma_b$ , and of  $\sigma_p$  in the water left on top of the samples. The measurement of  $\sigma_p$  was checked using a laboratory 4-electrode conductivity meter at 1 kHz.

Each material was dried in ten steps by slowly extracting solution from an initially saturated and thoroughly mixed sample. In this way 10 water contents between  $\theta = 0.10$  and saturation were created. The change in  $\theta$  was measured using a balance.

Since the salinity of the pore water was not allowed to change with  $\theta$ , drying by evaporation was avoided. The measured  $\sigma_p$  values are listed in the eighth column of Table 1. The average values with their standard deviations for  $\sigma_p$ , at the ten  $\theta$  steps, calculated according to Eq. [16] are listed in the last two columns. The seventh column lists the measured  $\sigma_p$  of the pore water extract.

Comparison of the  $\sigma_p$  values measured in the soil solution and the  $\sigma_p$  values calculated from  $\varepsilon'_b$  and  $\sigma_b$ , justifies the model of Eq. [16]. The values found for  $\varepsilon'_{\sigma_b=0}$  at which  $\sigma_b = 0$ , are listed in the sixth column.

**Table 1.** Soil composition and validation results.

Soil	Clay (%)	Silt (%)	Sand (%)	Organic matter (%)	Offset $\varepsilon'_{\sigma_b=0}$ (-)	Conductivity of pore water, $\sigma_p$ (mS.m <sup>-1</sup> )		
						Calculated		
						Average	Std. devn.	
Glass beads	-	-	-	-	7.6	100	90	10
Rockwool	-	-	-	-	4.1	300	310	10
Groesbeek	10	70	20	0.95	2.7	250	200	10
Wichmond	14	31	55	4.3	1.9	100	110	5
Ferralsol-A	63	26	11	0	4.4	80	50	6
Munnikenland	40	56	3	5	5.8	310	290	20
Attapulgite	100	0	0	0	3.1	130	130	10

## Conclusions

The relationship between simultaneously measured values of the real part of the permittivity,  $\epsilon'_b$ , and the electrical conductivity of the bulk soil,  $\sigma_b$ , measured at the same frequency, is approximately linear. Their measurements are both affected equally by the shape of the electrodes, by the contact between electrodes and soil and by the soil composition. In general this applies for any soil where the water content  $\theta > 0.10$ .

Due to the linear relationship between  $\epsilon'_b$  and  $\sigma_b$ , the ionic conductivity of the pore water in the soil,  $\sigma_p$ , can be found from a simultaneous measurement of  $\epsilon'_b$  and  $\sigma_b$  independently of  $\theta$ . Contact problems have only a minor effect on  $\sigma_p$  measurements. To facilitate calibration  $\epsilon'_{\sigma_b=0} = 4.1$  can be used as an average. In this case, calibration of the sensor for  $\sigma_p$  is not required.

---

*Note: the conversion formula in equation [16] gives the wrong answers in purely aqueous solutions (unless the soil parameter is set to zero). In order to overcome this, the HH2 changes its conversion formula when the permittivity is very close to water, and simply sets  $\sigma_p = \sigma_b$ .*

---



---

# References

1. Topp, G. C., J. L. Davis, A. P. Annan (1980). Electromagnetic determination of soil water content. *Water Resour. Res* **16**(3) 574-582
2. Whalley, W R (1993). Considerations on the use of time-domain reflectometry (TDR) for measuring soil moisture content. *Journal of Soil Sci.* **44**, 1-9
3. White, I, Knight, J H, Zegelin, S J, and Topp, G C (1994). Comments on 'Considerations on the use of time-domain reflectometry (TDR) for measuring soil water content' by W R Whalley. *Journal of Soil Sci.* **45**, 503-508
4. Roth, C H, Malicki, M A, and Plagge, R. (1992). Empirical evaluation of the relationship between soil dielectric constant and volumetric water content as the basis for calibrating soil moisture measurements. *Journal of Soil Sci.* **43**, 1-13
5. Knight, J.H. (1992). Sensitivity of Time Domain Reflectometry measurements to lateral variations in soil water content.
6. Dirksen, C., Dasberg S. (1993) Improved calibration of time domain reflectometry for soil water content measurements. *Soil Science Society of America Journal*, **57**, 660-667.
7. Hilhorst, M.A., Balendonck, J., Kampers, F.W.H. (1993) A broad-bandwidth mixed analog/digital integrated circuit for the measurement of complex impedances. *IEEE Journal of Solid-State Circuits*, **28**, No. 7, 764-769.
8. Hilhorst, M.A. (1998) *Dielectric characterisation of soil*. Doctoral Thesis, ISBN 90-5485-810-9, Wageningen Agricultural University, Wageningen, The Netherlands.
9. Kaatze, U., Uhlendorf, V. (1981) The dielectric properties of water at microwave frequencies. *Zeitschrift für Phys. Chem.*, Neue Folge, Bd. 126, 151-165.
10. Mualem, Y., Friedman, S.P. (1991) Theoretical prediction of electrical conductivity in saturated and unsaturated soil. *Water Resources Research*, **27**, 2771-2777
11. Malicki, M.A., Walczak, R.T., Koch, S., Flühler, H. (1994) Determining soil salinity from simultaneous readings of its electrical conductivity and permittivity using TDR. Proceedings: *Symposium on TDR in Environmental, Infrastructure and Mining Applications*, September 1994, held at Northwestern University, Evanston, Illinois, USA. Special Publication SP 19-94, US Department of Interior Bureau of Mines, 328-336
12. Nyfors, E., Vainikainen, P. (1989) *Industrial microwave sensors*. Artech Hous, Norwood, USA.
13. Rhoades, J.D., Shouse, P.J., Alves, W.J., Manteghi, N.A., Lesch, S.M. (1990) Determining soil salinity from soil electrical conductivity using different models and estimates, *Soil Science Society of America Journal*, **54**, 46-54.

---

# Definitions of Terms

The **Electrical Conductivity** ( $EC$ ) of a material is a measure of its ability to carry an electrical current. It is an “intrinsic” property of the material into which the electrodes are inserted, i.e. a property which is defined at a point and does not depend on how much material is present (q.v. density)

In contrast the **Electrical Conductance** ( $G$ ) is a measure of the current carrying ability of an “extensive” sample of material, and depends on the particular measurement set-up, particularly the length ( $L$ ) and cross-sectional area ( $A$ ) of the measurement cell.

*Conductivity* and *conductance* are related by the formula

$$EC = G \cdot \frac{L}{A}$$
$$= G \cdot C \quad (\text{S} \cdot \text{m}^{-1}), \text{ where } C \text{ is the } \mathbf{Cell Constant}.$$

*Electrical Conductivity* is measured in **Units** of Siemens per meter ( $\text{S} \cdot \text{m}^{-1}$ ). We have used  **$\text{mS} \cdot \text{m}^{-1}$**  throughout this manual because it is an SI preferred unit.

The following conversions apply:

$$1 \text{ mS} \cdot \text{m}^{-1} = 0.01 \text{ mS} \cdot \text{cm}^{-1}$$
$$= 10 \text{ } \mu\text{S} \cdot \text{cm}^{-1}$$

**Pore Water Conductivity** ( $EC_p$  or  $\sigma_p$ ) is the *electrical conductivity* of the water within the soil pores. It is determined by the concentration of different ions within the pore water, and by the temperature.

In contrast, the **Bulk Electrical Conductivity** ( $EC_b$  or  $\sigma_b$ ) is the total *electrical conductivity* of the soil, and is a function of *pore water conductivity*, soil particle conductivity, *soil moisture content*, and soil composition.

**Saturation Extract** is the solution extracted from a soil at its saturation water content. Because it is not easy to determine the saturation water content, the *saturation extract* is usually approximated by adding excess water (e.g. 5 litres of water to a 1 litre sample of soil), and then adjusting readings from the resulting extract appropriately.

**Soil Extract** is the solution separated from a soil (whether saturated or unsaturated) by filtration, suction or centrifuge. All these techniques introduce errors, because the extracted solutions differ significantly from the pore water.

**Soil Salinity** is the concentration of all soluble salts within a soil. It usually requires laboratory analysis to determine soil salinity directly, so it is conventionally represented by the *electrical conductivity* of the *saturation extract* ( $EC_{SE}$ ).

*Soil salinity* is partitioned into the following descriptive categories:

non-saline	0 - 200	mS.m <sup>-1</sup>
slightly saline	200 - 400	mS.m <sup>-1</sup>
moderately saline	400 - 800	mS.m <sup>-1</sup>
strongly saline	800 - 1600	mS.m <sup>-1</sup>
extremely saline	> 1600	mS.m <sup>-1</sup>

**Soil Water Content** is defined either in relation to the volume of soil:

$$\theta = \frac{V_{water}}{V_{sample}} \text{ m}^3 \cdot \text{m}^{-3},$$

or in relation to the mass of the dry soil:

$$w = \frac{m_{water}}{m_{sample}} \text{ g} \cdot \text{g}^{-1}$$

The **Permittivity** ( $\epsilon$ ) of a material characterises its response to the polarising effect of an applied electric field. It is usually represented as a complex number,  $\epsilon = \epsilon' - j\epsilon''$ , where the real part of the permittivity,  $\epsilon'$ , represents the energy stored, and the imaginary component,  $\epsilon''$ , represents the total energy absorption or loss. Both values are frequency and temperature dependent.

Permittivity is commonly used as a means of measuring water content, because the real permittivity of water is ~80 at 20 MHz, 25°C, whereas the permittivity of most soil particles is typically in the range 3 to 8.

**Dielectric** is best used as a descriptive term, e.g. “*dielectric materials*” usually refers to insulating materials with a high relative permittivity.

**Dielectric constant** is sometimes used interchangeably for *permittivity*, but may be more rigorously defined as the real part of the *permittivity* in a static electric field.

**Saturation** is the moisture content at which all the air within the pores has been replaced by water. It's not a stable situation

because the water will immediately start to drain through. It's a property of soil type only.

**Field Water Capacity** (or **Field Capacity**) is the moisture content obtained when a saturated soil has been allowed to drain (sometimes taken as 2 days later, sometimes when drainage has become “negligible”).

It's a property of soil type only, and typically varies between  $0.1 \text{ m}^3 \cdot \text{m}^{-3}$  for sandy soils up to about  $0.45 \text{ m}^3 \cdot \text{m}^{-3}$  for clay soils.

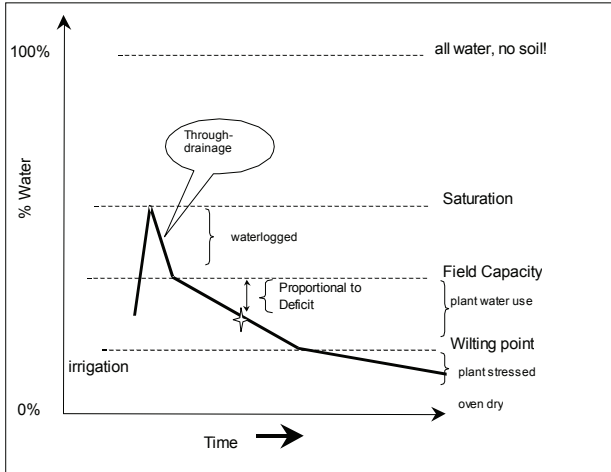

**Wilting Point** (WP) is the moisture content at which a particular crop is unable to extract any more water. Conventionally this is taken to correspond to a matric potential of  $-1500 \text{ kPa}$ , but it's really much more variable than that suggests. It's a property of soil type and crop type, and can vary between about  $0.04 \text{ m}^3 \cdot \text{m}^{-3}$  for sandy soils to  $0.22 \text{ m}^3 \cdot \text{m}^{-3}$  for clay soils.

**Dry** is zero moisture content.

**Available Water Capacity** is the difference between Field Capacity and Wilting Point.

**Water Deficit** is the amount of irrigation water or rainfall (mm) that has to be added to a soil profile in order to bring it back up to field capacity.

---

# Interfacing to the WET Sensor

If you want to use the WET sensor for irrigation or fertigation control, there is a separate manual detailing connections and data-handling requirements for WET1.

**WET-sensor  
Application note**



Wageningen, March, 30<sup>th</sup> 2001  
Joz. Salendörck, Max Hilhorst  
IMAG B.V.  
Report Number: 2001-07

# Technical Support

## ***Terms and Conditions of Sale***

Our Conditions of Sale (ref: COND: 1/00) set out Delta-T's legal obligations on these matters. The following paragraphs summarise Delta-T's position but reference should always be made to the exact terms of our Conditions of Sale, which will prevail over the following explanation.

Delta-T warrants that the goods will be free from defects arising out of the materials used or poor workmanship for a period of **twelve months** from the date of delivery.

Delta-T shall be under no liability in respect of any defect arising from fair wear and tear, and the warranty does not cover damage through misuse or inexperienced servicing, or other circumstances beyond our control.

If the buyer experiences problems with the goods they shall notify Delta-T (or Delta-T's local distributor) as soon as they become aware of such problem.

Delta-T may rectify the problem by supplying replacement parts free of charge, or by repairing the goods free of charge at Delta-T's premises in the UK, during the warranty period,

If Delta-T requires that goods under warranty be returned to them from overseas for repair, Delta-T shall not be liable for the cost of carriage or for customs clearance in respect of such goods. However, we much prefer to have such returns discussed with us in advance, and we may, at our discretion, waive these charges.

Delta-T shall not be liable to supply products free of charge or repair any goods where the products or goods in question have been discontinued or have become obsolete, although Delta-T will endeavour to remedy the buyer's problem.

Delta-T shall not be liable to the buyer for any consequential loss, damage or compensation whatsoever (whether caused by the negligence of Delta-T, our employees or distributors or otherwise) which arise from the supply of the goods and/or services, or their use or resale by the buyer.

Delta-T shall not be liable to the buyer by reason of any delay or failure to perform our obligations in relation to the goods and/or services, if the delay or failure was due to any cause beyond the Delta-T's reasonable control.

## ***Service and Spares***

Users in countries that have a Delta-T Distributor or Technical Representative should contact them in the first instance.

Spare parts for our own instruments can be supplied from our works. These can normally be despatched within a few working days of receiving an order.

Spare parts and accessories for sensors or other products not manufactured by Delta-T, may have to be obtained from our supplier, and a certain amount of additional delay is inevitable.

No goods or equipment should be returned to Delta-T without first obtaining the agreement of Delta-T or our distributor.

On receipt at Delta-T, the goods will be inspected and the user informed of the likely cost and delay. We normally expect to complete repairs within a few working days of receiving the equipment. However, if the equipment has to be forwarded to our original supplier for specialist repairs or recalibration, additional delays of a few weeks may be expected.

## ***Technical Support***

Technical Support is available on Delta-T products and systems. Users in countries that have a Delta-T Distributor or Technical Representative should contact them in the first instance.

Technical Support questions received by Delta-T will be handled by our Tech Support team. Your initial enquiry will be acknowledged immediately with a "T number" and an estimate of time for a detailed reply. Make sure to quote our T number subsequently so that we can easily trace any earlier correspondence.

In your enquiry, always quote instrument serial numbers, software version numbers, and the approximate date and source of purchase where these are relevant.

### ***Contact details:***

Tech Support Team  
Delta-T Devices Ltd  
130 Low Road, Burwell, Cambridge CB25 0EJ, U.K.  
email: [tech.support@delta-t.co.uk](mailto:tech.support@delta-t.co.uk)  
Web site: [www.delta-t.co.uk](http://www.delta-t.co.uk)  
Tel: +44 (0) 1638 742922  
Fax: +44 (0) 1638 743155

---

## Acknowledgements:

These sensors have been developed in co-operation with:



**GREENHOUSE TECHNOLOGY**

**WAGENINGEN UR**

**Institute of Agricultural and Environmental Engineering (IMAG-BV),**  
P.O.-Box 43, 6700 AA Wageningen, the Netherlands.

Web site: [www.wur.nl](http://www.wur.nl)

*Designers of the WET Sensor & the integrated circuit which enables accurate measurement of the permittivity and conductivity of the bulk soil or media*



**Saint-Gobain Cultilène B.V.,** Zeusstraat 2, 5048 CA TILBURG, The Netherlands. Tel: +31 (0)13-5780057,

Web site: [www.cultilene.com](http://www.cultilene.com)

*Sponsors of research into horticultural media applications & suppliers of horticultural media calibrations*



**PRAKTIJKONDERZOEK  
PLANT & OMGEVING**

**WAGENINGEN UR**

**Applied Plant Research, Division Glasshouse Horticulture**  
**(Praktijkonderzoek Plant & Omgeving B.V.),** the former Research Station for Floriculture and Glasshouse Vegetables, P.O. Box 8, 2670 AA Naaldwijk, The Netherlands.

Web site: [www.ppo.wur.nl](http://www.ppo.wur.nl)

*Developers of the WET calibrations for horticultural media. Copyright © 2001 Praktijkonderzoek Plant & Omgeving B.V.*



# Index

## A

**Accuracy, 21**  
**ASIC, 30**

## B

**Battery life, 9**

## C

**Calibration**  
file, 6, 9, 11, 19  
generalised, 4, 12, 14, 15, 25  
recalibration, 20  
sensor, 19  
soil, 14, 19  
soil-specific, 15  
WET-CL, 12, 15, 21

**Case, 6**

**Compost, 15**  
coir, 15  
glasswool, 15  
mineral wool, 15  
peat, 15

**Conductivity**  
bulk, 18  
Electrical, 4, 27, 34  
ionic, 18, 24, 27, 28, 29, 32  
**pore water, 4, 5, 10, 11, 12, 13,**  
17, 20, 23, 26, 34

**Connection, 8, 9, 21, 37**

**Cultilène, 15, 40**

## D

**Data**  
erase, 11  
plot, 11  
root depth, 11  
sample, 11

**Description, 4, 6, 15**

**Dielectric properties, 4, 5, 19, 22,**  
23, 24, 30, 33

**Display, 11, 16, 19**  
reading, 22, 23

## E

**Electrical**  
conductance, 34  
conductivity, 4, 27, 34

## F

**Field capacity, 11, 12, 14, 26, 36**  
**Frequency, 24, 27, 30, 32, 35**

## H

**HH2, 4, 5, 6, 8, 9, 10, 11, 12, 13,**  
15, 16, 18, 19, 20, 32  
HH2Read, 9

## I

**IMAG, ii, 15, 30, 40**  
**Insertion, 4, 6, 7, 10, 22, 23**  
**Ions, 13, 18, 29, 34**

## M

**Maintenance, 7**  
**Measurement Principle, 5**  
**Memory, 9**  
**Mineral soil, 12**  
**Moisture Meter, 4, 5, 6, 8, 9, 10,**  
11, 12, 13, 15, 16, 18, 19, 20,  
32

## N

**Notes, 21, 22, 23**

## O

**Options, 10, 11**  
**Organic soil, 12, 31**  
**Output file, 13**

## P

**Permittivity, 21, 35**  
**PPO, 15, 40**

## Q

**Quick start, 8**

## R

**Range, 21**

**Reading**

accuracy, 21

range, 21

**Readings**

range, 7, 15, 16, 17, 27, 29, 35

**Recalibration, 20**

**References, 33**

**Rooting depth, 11**

## S

**Salinity, 30, 31, 33, 35**

**Sensor care, 7**

**Servicing, 39**

**Set**

device, 8, 9, 11

display, 11, 16, 19

field capacity, 11, 12, 36

soil set-up, 10, 12

soil type, 10, 12

temperature compensation, 23

units, 11, 21, 34

**Software**

CD or disk, 6

**Soil**

calibration, 14, 19

clay, 15, 17, 22, 23, 25, 29, 36

dry, 7, 15, 16, 17, 27, 29, 35

extract, 34

magnetic, 22, 23

mineral, 12

moisture, 4, 14, 21, 23, 33, 34

organic, 12, 31

parameter, 12, 17, 19

sand, 12, 31

**Soil type, 10, 12**

**Specifications, 21**

**Store, 8, 10**

## T

**Temperature, 4, 5, 10, 11, 13, 18, 19, 21, 23**

compensation, 13, 14, 18, 20, 23

**Theory, 15, 30**

## U

**Units, 11, 21, 34**

**Unpacking, 6**

## W

**Water content, 4, 5, 8, 10, 11, 12, 14, 15, 16, 17, 21, 22, 23, 25, 26, 29, 31, 32, 33, 34, 35**

**Water deficit, 26, 36**

**WET-CL1, 6, 12, 15, 21**